

LM4668 Boomer® Audio Power Amplifier Series

10W High-Efficiency Mono BTL Audio Power Amplifier

General Description

The LM4668 is a high efficiency switching audio power amplifier primarily designed for demanding applications in flat panel monitors and TV's. It is capable of delivering 6W to an 8Ω mono BTL load with less than 1% distortion (THD+N) from a 12V_{DC} power supply.

Boomer audio power amplifiers were designed specifically to provide high quality output power with a minimal amount of external components. The LM4668 features a micro-power, active-low shutdown mode, an internal thermal shutdown protection mechanism, and short circuit protection.

The LM4668 contains advanced transient ("pop and click") suppression circuitry that eliminates noises that would otherwise occur during turn-on and turn-off transitions.

Key Specifications

- Power Output BTL ($V_{DD} = 14V$, $f_{IN} = 1kHz$, $THD+N = 10%$, $R_L = 8\Omega$) 10W (typ)
- Quiescent Power Supply Current 30mA (typ)
- Efficiency ($V_{DD} = 12V$, $f_{IN} = 1kHz$, $R_L = 8\Omega$, $P_{OUT} = 6W$) 79% (typ)
- Shutdown Current 0.15mA (typ)
- Fixed Gain 30dB (typ)

Features

- Soft-start circuitry eliminates noise during turn-on transition
- Low current shutdown mode
- Low quiescent current
- 6W BTL output, $R_L = 8\Omega$
- Short circuit protection
- Fixed, internally set gain of 30dB

Applications

- Flat Panel Monitors
- Flat Panel TVs
- Computer Sound Cards

Connection Diagrams

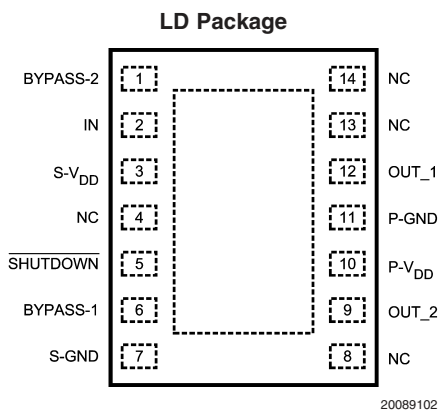

Top View
Order Number LM4668LD
See NS Package Number LDC14A

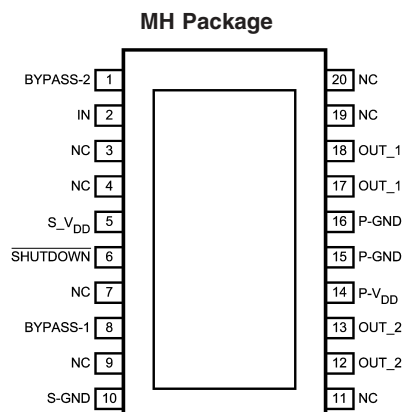

Top View
Order Number LM4668MH
See NS Package Number MXA20A

Boomer® is a registered trademark of National Semiconductor Corporation.

Typical Application

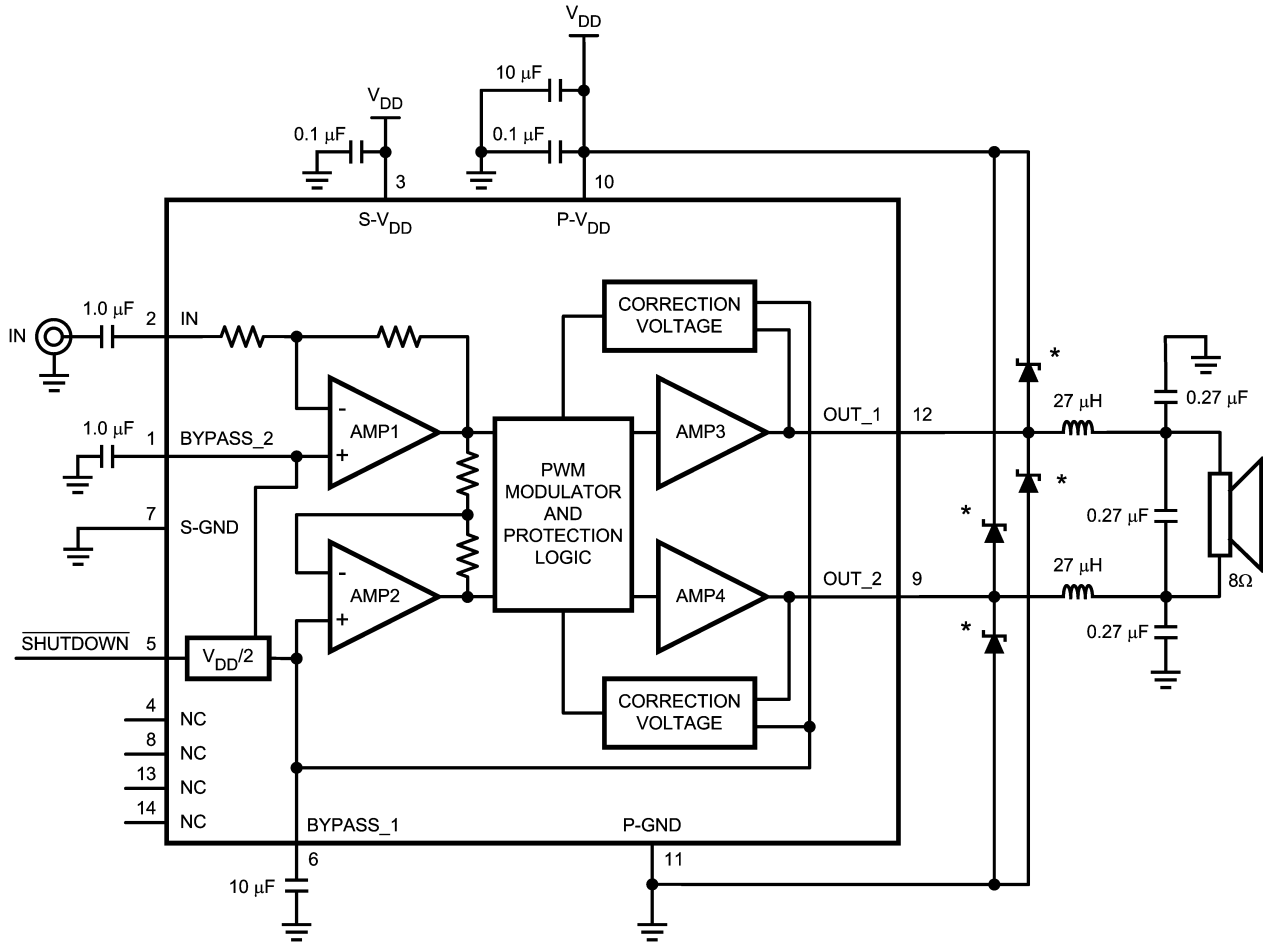

20089101

FIGURE 1. Typical Audio Amplifier Application Circuit (* Zetex ZHCS506)

Absolute Maximum Ratings (Notes 1, 2)

If Military/Aerospace specified devices are required, please contact the National Semiconductor Sales Office/Distributors for availability and specifications.

Supply Voltage	16V
Storage Temperature	-65°C to +150°C
Input Voltage	-0.3V to $V_{DD} + 0.3V$
Power Dissipation (Note 3)	Internally limited
ESD Susceptibility (Note 4)	2000V
ESD Susceptibility (Note 5)	200V

Junction Temperature (LD and MH)	150°C
Thermal Resistance	
θ_{JC}	2°C/W
θ_{JA}	40°C/W

Operating Ratings

Temperature Range	$T_{MIN} \leq T_A \leq T_{MAX}$	-40°C ≤ T_A ≤ 85°C
Supply Voltage (Note 10)		$9V \leq V_{DD} \leq 14.0V$

Electrical Characteristics for the LM4668 (Note 1)

The following specifications apply for the circuit shown in Figure 1 operating with $V_{DD} = 12V$, $R_L = 8\Omega$, and $f_{IN} = 1kHz$, unless otherwise specified. Limits apply for $T_A = 25^\circ C$.

Symbol	Parameter	Conditions	LM4668		Units (Limits)
			Typical (Note 6)	Limit (Notes 7, 8)	
I_{DD}	Quiescent Power Supply Current	$V_{IN} = 0V$, $I_O = 0A$, $R_L = 8\Omega$	30	65	mA (max)
I_{SD}	Shutdown Current	$V_{SHUTDOWN} = GND$ (Note 9)	0.15		mA
A_V	Amplifier Gain	BTL output voltage with respect to input voltage, $V_{IN} = 100mV_{p-p}$	30	32 28	dB (max) dB (min)
P_O	Output Power	THD+N = 1% (max) THD+N = 10%, $V_{DD} = 14V$	6 10	5	W (min) W
THD+N	Total Harmonic Distortion + Noise	$P_{OUT} = 1W_{RMS}$	0.2		%
f_{BW}	Frequency Response Bandwidth	$P_{OUT} = 6W$, post filter, -3dB relative to the output amplitude at 1kHz, See Figure 1	20 20000		Hz Hz
η	Efficiency	$P_{OUT} = 6W$, including output filter	79		%
ϵ_N	Output Noise	A-Weighted Filter, $V_{IN} = 0V$	220		μV
SNR	Signal-to-Noise Ratio	A-Weighted Filter, $P_{OUT} = 6W$ $A_V = 30dB$	90		dB
PSRR	Power Supply Rejection Ratio	$V_{RIPPLE} = 20mV_{p-p}$, $C_{BYPASS_1} = 10\mu F$, input referred $f = 50Hz$ $f = 60Hz$ $f = 100Hz$ $f = 120Hz$ $f = 1kHz$	79 82 85 84 75		dB
t_{WU}	Wake-Up time	$C_{BYPASS} = 10\mu F$	600		ms
T_{SD}	Thermal Shutdown Temperature		170		°C (min) °C (max)
V_{SDIH}	Shutdown Voltage Input High			4	V (min)
V_{SDIL}	Shutdown Voltage Input Low			1.5	V (max)

Note 1: All voltages are measured with respect to the GND pin unless otherwise specified.

Note 2: Absolute Maximum Ratings indicate limits beyond which damage to the device may occur. Operating Ratings indicate conditions for which the device is functional, but do not guarantee specific performance limits. Electrical Characteristics state DC and AC electrical specifications under particular test conditions which guarantee specific performance limits. This assumes that the device is within the Operating Ratings. Specifications are not guaranteed for parameters where no limit is given, however, the typical value is a good indication of device performance.

Note 3: The maximum power dissipation must be de-rated at elevated temperatures and is dictated by T_{JMAX} , θ_{JA} , and the ambient temperature T_A . The maximum allowable power dissipation is $P_{DMAX} = (T_{JMAX} - T_A)/\theta_{JA}$ or the number given in Absolute Maximum Ratings, whichever is lower. For the LM4668 typical application (shown in Figure 1) with $V_{DD} = 12V$, $R_L = 8\Omega$ stereo operation, the total power dissipation is 900mW. $\theta_{JA} = 40^\circ C/W$

Note 4: Human body model, 100pF discharged through a 1.5k Ω resistor.

Note 5: Machine model, 220pF – 240pF discharged through all pins.

Note 6: Typical values are measured at 25°C and represent the parametric norm.

Note 7: Limits are guaranteed to National's AOQL (Average Outgoing Quality Level).

Electrical Characteristics for the LM4668 (Note 1) (Continued)

Note 8: Datasheets min/max specification limits are guaranteed by design, test, or statistical analysis.

Note 9: Shutdown current is measured in a normal room environment. The SHUTDOWN pin should be driven as close as possible to GND for minimum shutdown current.

Note 10: Please refer to "Under Voltage Protection" on page 8 under "General Features."

Typical Performance Characteristics

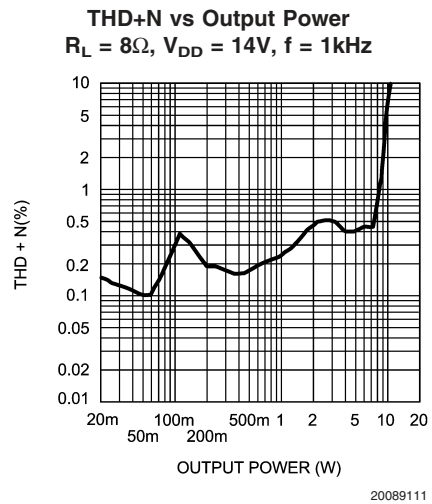
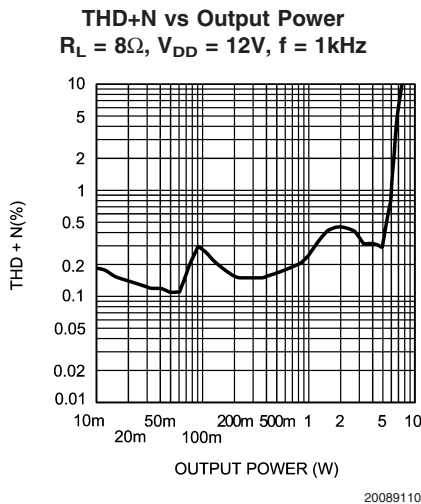
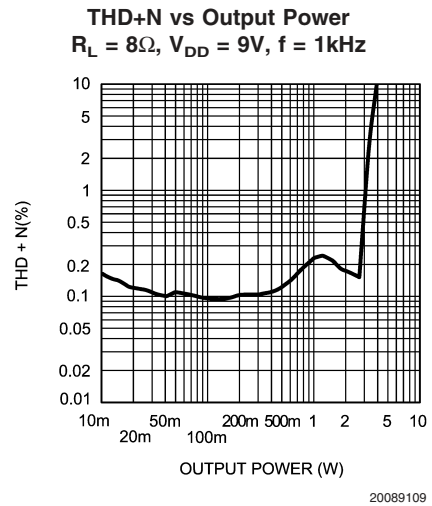
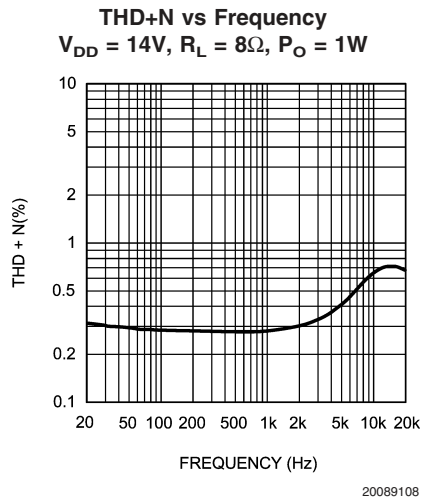
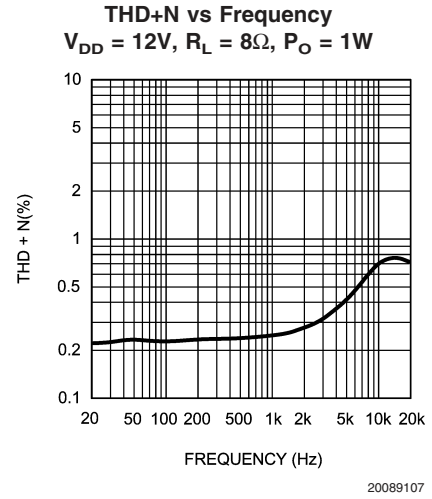
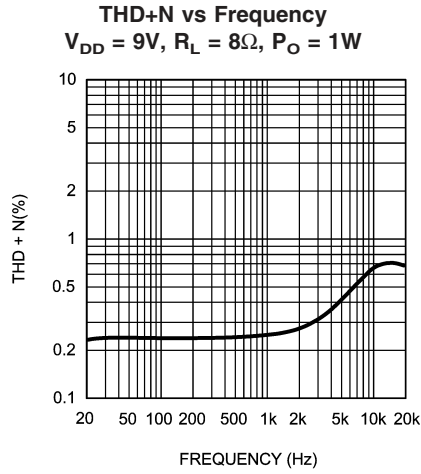

Typical Performance Characteristics (Continued)

Amplifier Output Power vs Power Supply Voltage
 $R_L = 8\Omega, f = 1\text{kHz}$

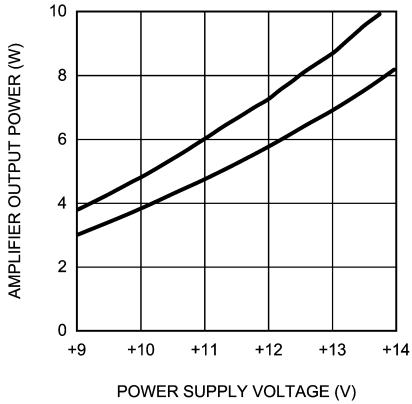

20089112

Amplifier Output Magnitude vs Frequency
 $R_L = 8\Omega, V_{DD} = 12\text{V}$

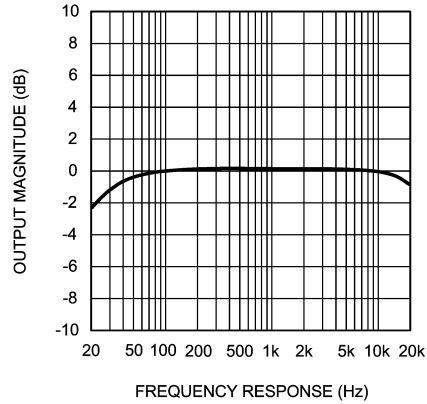

20089113

Power Rejection Ratio vs Frequency
 $V_{DD} = 9\text{V}, R_L = 8\Omega, \text{Input Referred}$

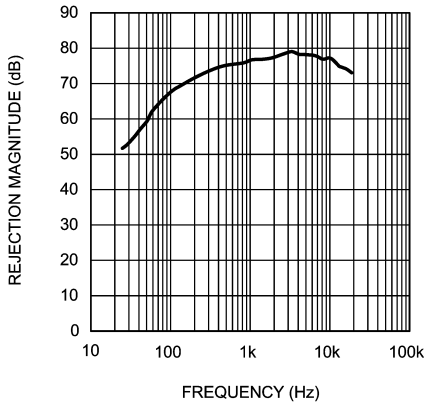

20089114

Power Rejection Ratio vs Frequency
 $V_{DD} = 12\text{V}, R_L = 8\Omega, \text{Input Referred}$

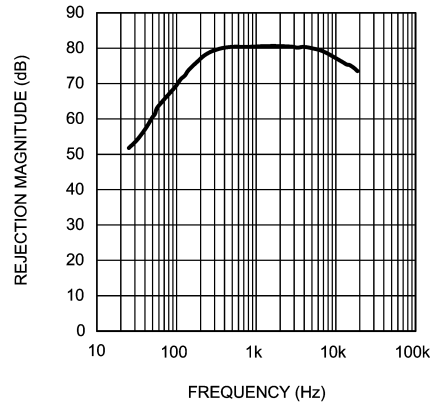

20089115

Power Rejection Ratio vs Frequency
 $V_{DD} = 14\text{V}, R_L = 8\Omega, \text{Input Referred}$

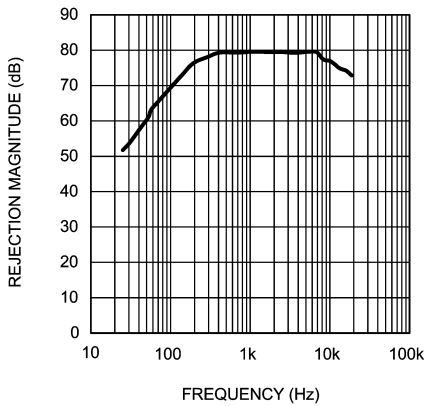

20089116

Amplifier Power Dissipation vs Amplifier Load Dissipation
 $V_{DD} = 14\text{V}, R_L = 8\Omega, f = 1\text{kHz}$

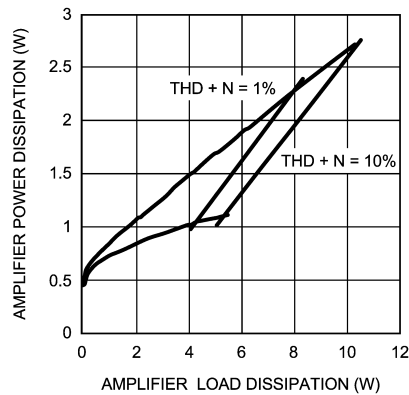

20089117

Typical Performance Characteristics (Continued)

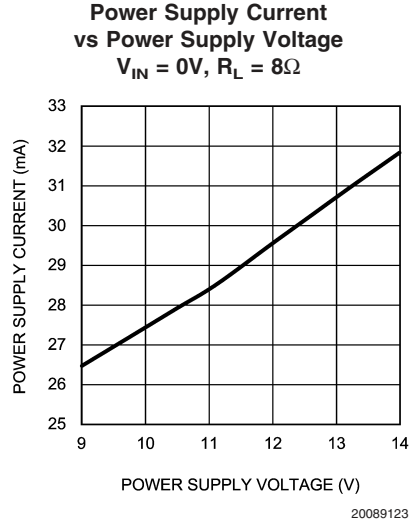
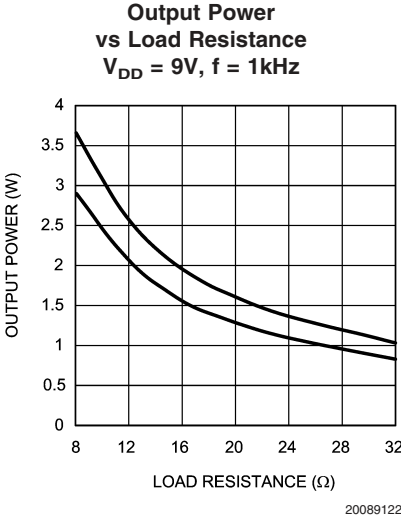
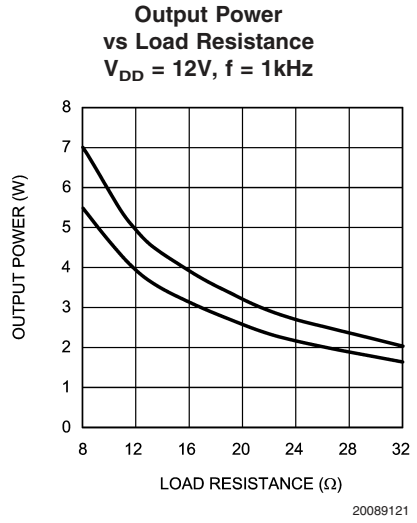
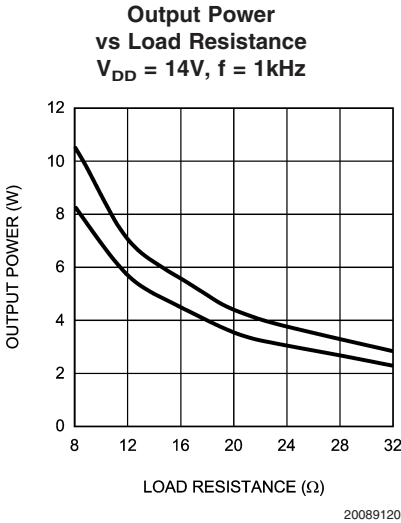
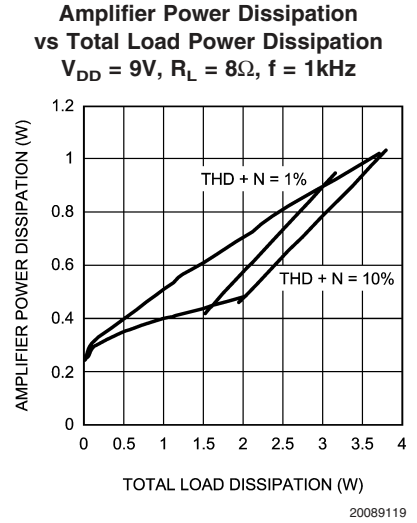
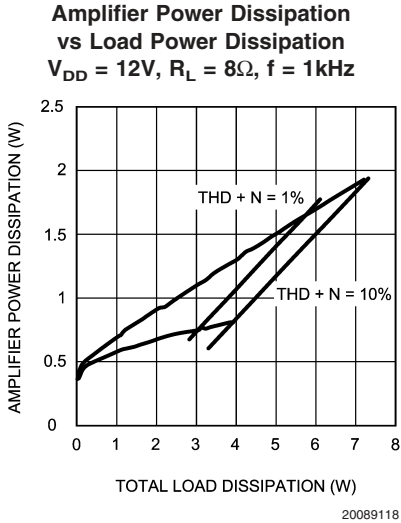

Typical Performance Characteristics (Continued)

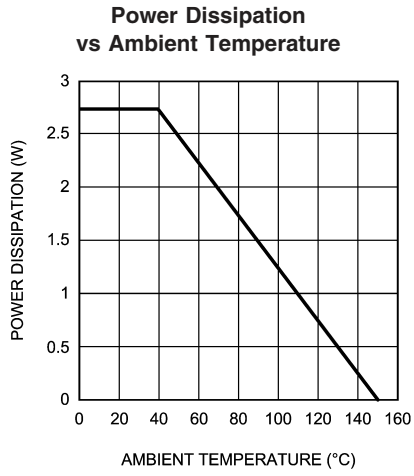

General Features

SYSTEM FUNCTIONAL INFORMATION

Modulation Technique

Unlike typical Class D amplifiers that use single-ended comparators to generate a pulse-width modulated switching waveform and RC timing circuits to set the switching frequency, the LM4668 uses a balanced differential floating modulator. Oscillation is a result of injecting complimentary currents onto the respective plates of a floating, on-die capacitor. The value of the floating capacitor and value of the components in the modulator's feedback network and sets the nominal switching frequency at 450kHz. Modulation results from imbalances in the injected currents. The amount of current imbalance is directly proportional to the applied input signal's magnitude and frequency.

Using a balanced, floating modulator produces a Class D amplifier that is immune to common mode noise sources such as substrate noise. This noise occurs because of the high frequency, high current switching in the amplifier's output stage. The LM4668 is immune to this type of noise because the modulator, the components that set its switching frequency, and even the load all float with respect to ground.

The balanced modulator's pulse width modulated output drives the gates of the LM4668's H-bridge configured output power MOSFETs. The pulse-train present at the power MOSFETs' output is applied to an LC low pass filter that removes the 450kHz energy component. The filter's output signal, which is applied to the driven load, is an amplified replica of the audio input signal.

Shutdown Function

The LM4668's active-low shutdown function allows the user to place the amplifier in a shutdown mode while the system power supply remains active. Activating shutdown deactivates the output switching waveform and minimizes the quiescent current. Applying logic 0 (GND) to pin 8 enables the shutdown function. Applying logic 1 ($4V \leq V_{\text{LOGIC}} \leq V_{\text{DD}}$) to pin 8 disables the shutdown function and restores full amplifier operation.

Under Voltage Protection

The under voltage protection disables the output driver section of the LM4668 while the supply voltage is below 8V. This condition may occur as power is first applied or during low line conditions, changes in load resistance, or when power supply sag occurs. The under voltage protection ensures that all of the LM4668's power MOSFETs are off. This action eliminates shoot-through current and minimizes output transients during turn-on and turn-off. The under voltage protection gives the digital logic time to stabilize into known states, further minimizing turn output transients.

Turn-On Time

The LM4668 has an internal timer that determines the amplifier's turn-on time. After power is first applied or the part returns from shutdown, the nominal turn-on time is 600ms. This delay allows all externally applied capacitors to charge to a final value of $V_{\text{DD}}/2$. Further, during turn-on, the outputs are muted. This minimizes output transients that may occur while the part settles into its quiescent operating mode.

Output Stage Fault Detection And Protection

The output stage MOSFETs are protected against output conditions that could otherwise compromise their operational status. An onboard fault detection circuit continuously monitors the signal on each output MOSFET's gate and compares it against the respective drain voltage. When a condition is detected that violates a MOSFET's Safe Operating Area (SOA), the drive signal is disconnected from the output MOSFETs' gates. The fault detect circuit maintains this protective condition for approximately 600ms, at which time the drive signal is reconnected. If the fault condition is no longer present, normal operation resumes.

If the fault condition remains, however, the drive signal is again disconnected.

Thermal Protection

The LM4668 has thermal shutdown circuitry that monitors the die temperature. Once the LM4668 die temperature reaches 170°C, the LM4668 disables the output switching waveform and remains disabled until the die temperature falls below 140°C (typ).

Over-Modulation Protection

The LM4668's over-modulation protection is a result of the preamplifier's (AMP1 and AMP2, Figure 1) inability to produce signal magnitudes that equal the power supply voltages. Since the preamplifier's output magnitude will always be less than the supply voltage, the duty cycle of the amplifier's switching output will never reach zero. Peak modulation is limited to a nominal 95%.

Application Hints

SUPPLY BYPASSING

Correct power supply bypassing has two important goals. The first is to reduce noise on the power supply lines and minimize deleterious effects that the noise may cause to the amplifier's operation. The second is to help stabilize an unregulated power supply and to improve the supply's transient response under heavy current demands. These two goals require different capacitor value ranges. Therefore, various types and values are recommended for supply bypassing. For noise de-coupling, generally small ceramic capacitors (0.01μF to 0.1μF) are recommended. Larger value (1μF to 10μF) tantalum capacitors are needed for the transient current demands. These two capacitors in parallel will do an adequate job of removing most noise from the supply rails and providing the necessary transient current. These capacitors should be placed as close as possible to each IC's supply pin(s) using leads as short as possible.

The LM4668 has two V_{DD} pins: a power V_{DD} (PV_{DD}) and a signal V_{DD} (SV_{DD}). The parallel combination of the low value ceramic (0.1μF) and high value tantalum (10μF) should be used to bypass the PV_{DD} pin. A small value (0.1μF) ceramic or tantalum can be used to bypass the SV_{DD} pin.

AMPLIFIER OUTPUT FILTERING

The LM4668 requires a lowpass filter connected between the amplifier's bridge output and the load. The second-order LC output filter shown in Figure 1 creates the lowpass response that is necessary to attenuate signal energy at the amplifier's switching frequency. It also serves to suppress EMI. Together, the output filter's 0.27μF capacitors and the recommended minimum inductor value of 27μH produce a

Application Hints (Continued)

nominal cutoff frequency of 47kHz. This cutoff frequency ensures that the attenuation is much less than 3dB at 20kHz.

The output filter cutoff frequency and topology are also optimized for operational efficiency. A higher cutoff frequency compromises efficiency, whereas a lower cutoff frequency compromises the high frequencies within the audio frequency range. The filter's topology also minimizes high frequency peaking, which can also decrease the amplifier's efficiency.

The output filter inductors must have a current rating that exceeds the amplifier's output current when driving the load to maximum dissipation. Assuming a load dissipation of 10W in an 8Ω load with the amplifier operating on a 14V supply, the RMS current is 1.1A. In this case, the inductors' current rating should be at least $1.2A_{RMS}$ or $1.6A_{PEAK}$.

If a different output filter cutoff frequency (f_C) is desired, the following brief discussion covers the selection of the capacitor and inductor values. In the following equations, R_L is the load resistance and C_L is three times the final value of the three common-mode filter capacitor found between the two output filter inductors (each inductor is L) as shown in Figure 1. When calculating values for L and C_L , R_L should be 8Ω, since the LM4668 is specified for 8Ω loads.

The filter's two inductors are equal to

$$L = R_L / 2\pi f_C \quad (1)$$

and each of the three capacitors are equal to

$$C = L / 1.5R^2 \quad (2)$$

SCHOTTKY DIODE AMPLIFIER OUTPUT OVERDRIVE PROTECTION

The Schottky diodes shown in Figure 1 provide protection against an over-voltage condition that may be caused by inductor-induced transients. These diodes are necessary when the nominal supply voltage exceeds 12V, the load impedance falls below 6Ω or the ambient temperature in the operating environment rises above 50°C.

THD+N MEASUREMENTS AND OUT OF AUDIO BAND NOISE

THD+N (Total Harmonic Distortion plus Noise) is a very important parameter by which all audio amplifiers are measured. Often it is shown as a graph where either the output power or frequency is changed over the operating range. A very important variable in the measurement of THD+N is the bandwidth-limiting filter at the input of the test equipment. Class D amplifiers, by design, switch their output power devices at a much higher frequency than the accepted audio range (20Hz - 20kHz). Alternately switching the output voltage between V_{DD} and GND allows the LM4668 to operate at much higher efficiency than that achieved by traditional Class AB amplifiers. Switching the outputs at high frequency also increases the out-of-band noise. Under normal circumstances the output lowpass filter significantly reduces this out-of-band noise. If the low pass filter is not optimized for a given switching frequency, there can be significant increase in out-of-band noise. THD+N measurements can be significantly affected by out-of-band noise, resulting in a higher than expected THD+N measurement. To achieve a more accurate measurement of THD, the test equipment's input bandwidth of the must be limited. Some common upper filter points are 22kHz, 30kHz, and 80kHz. The input filter limits the noise component of the THD+N measurement to a smaller bandwidth resulting in a more real-world THD+N value.

RECOMMENDED PRINTED CIRCUIT BOARD LAYOUT

Figures 2 through 4 show the recommended two-layer PC board layout that is optimized for the 14-pin MH-packaged LM4668 and associated external components. Figures 5 through 7 show the recommended two-layer PC board layout that is optimized for the 14-pin LD-packaged LM4668 and associated external components. These circuits are designed for use with an external 12V supply and 8Ω speakers (or load resistors). This circuit board is easy to use. Apply 12V and ground to the board's V_{DD} and GND terminals, respectively. Connect speakers (or load resistors) between the board's -OUT and +OUT terminals. Apply the input signal to the input pin labeled -IN.

Demonstration Board Layout

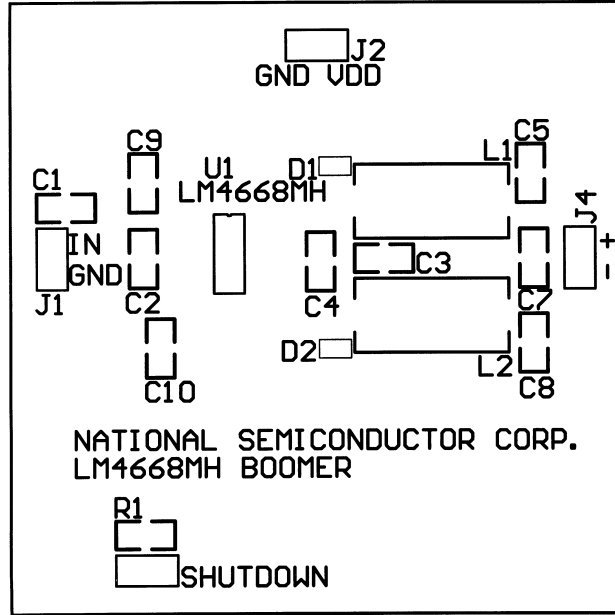

20089103

FIGURE 2. Recommended MH PCB Layout
Top Silkscreen

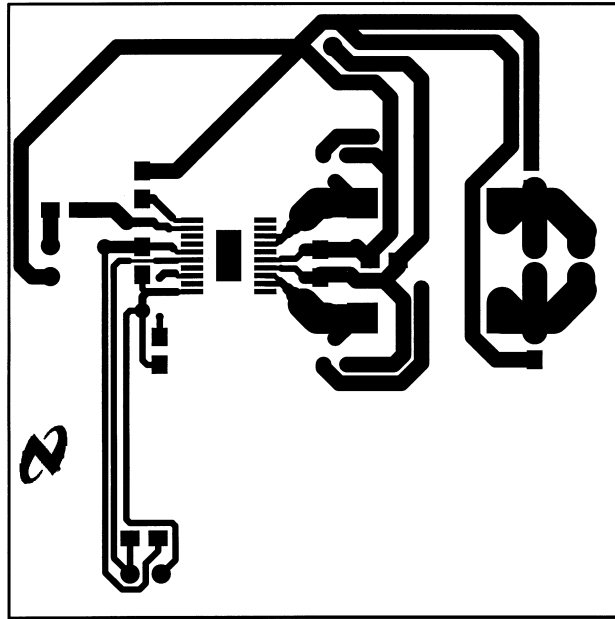

20089104

FIGURE 3. Recommended MH PCB Layout
Top Layer

Demonstration Board Layout (Continued)

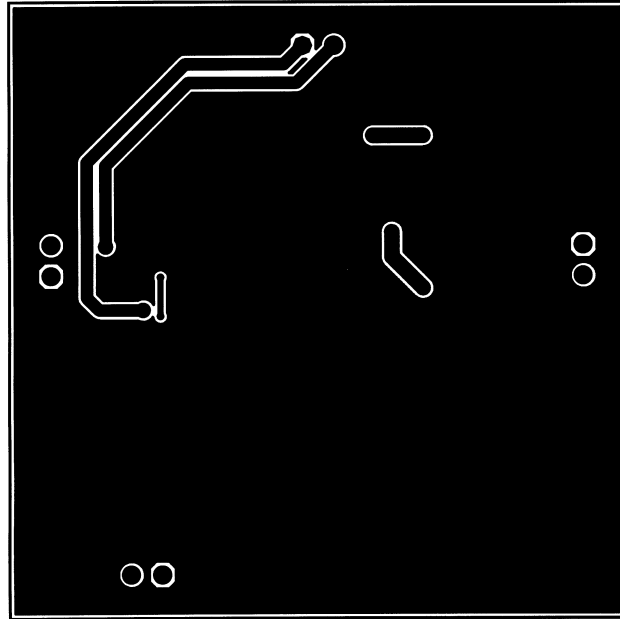

20089105

**FIGURE 4. Recommended MH PCB Layout
Bottom Layer**

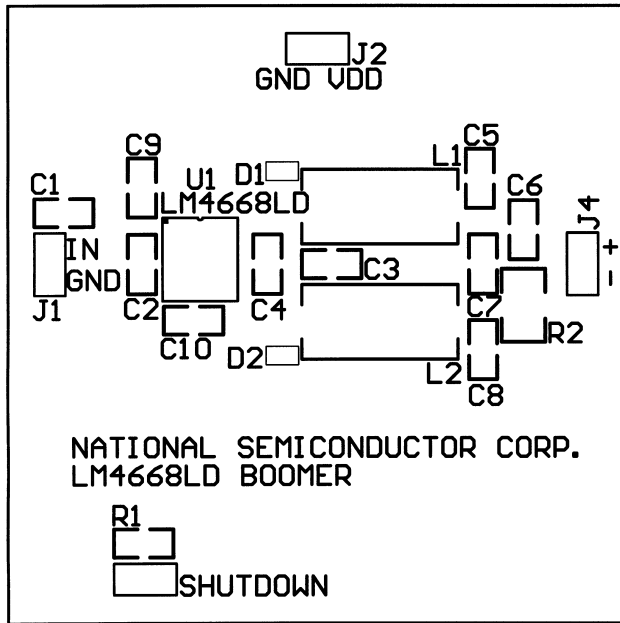

20089125

**FIGURE 5. Recommended LD PCB Layout
Top Silkscreen Layer**

Demonstration Board Layout (Continued)

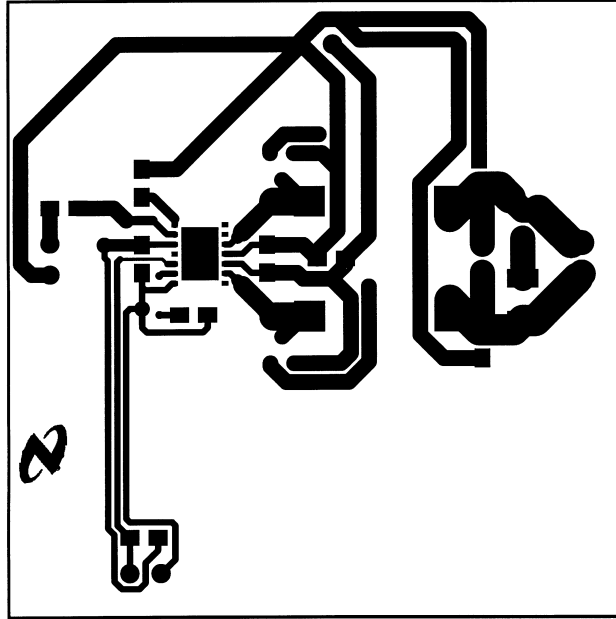

20089126

FIGURE 6. Recommended LD PCB Layout
Top Layer

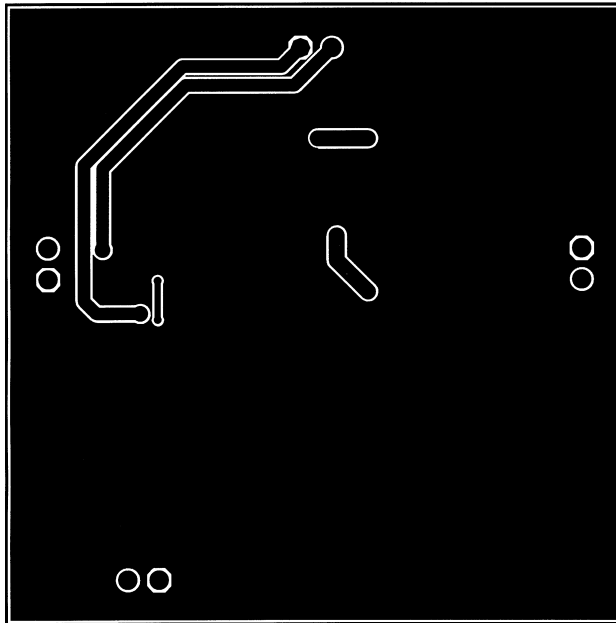

20089127

FIGURE 7. Recommended LD PCB Layout
Bottom Layer

Physical Dimensions inches (millimeters)

unless otherwise noted

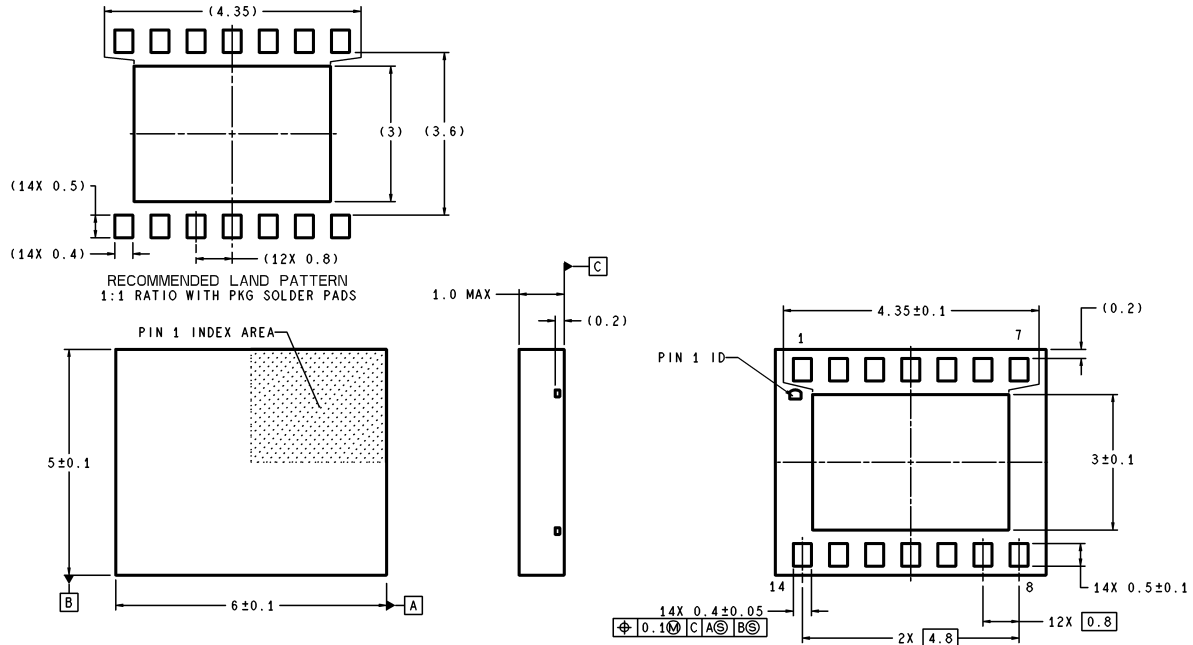

DIMENSIONS ARE IN MILLIMETERS

LDC14A (Rev. A)

LD Package
Order Number LM4668LD
NS Package Number LDC14A

Physical Dimensions inches (millimeters) unless otherwise noted (Continued)

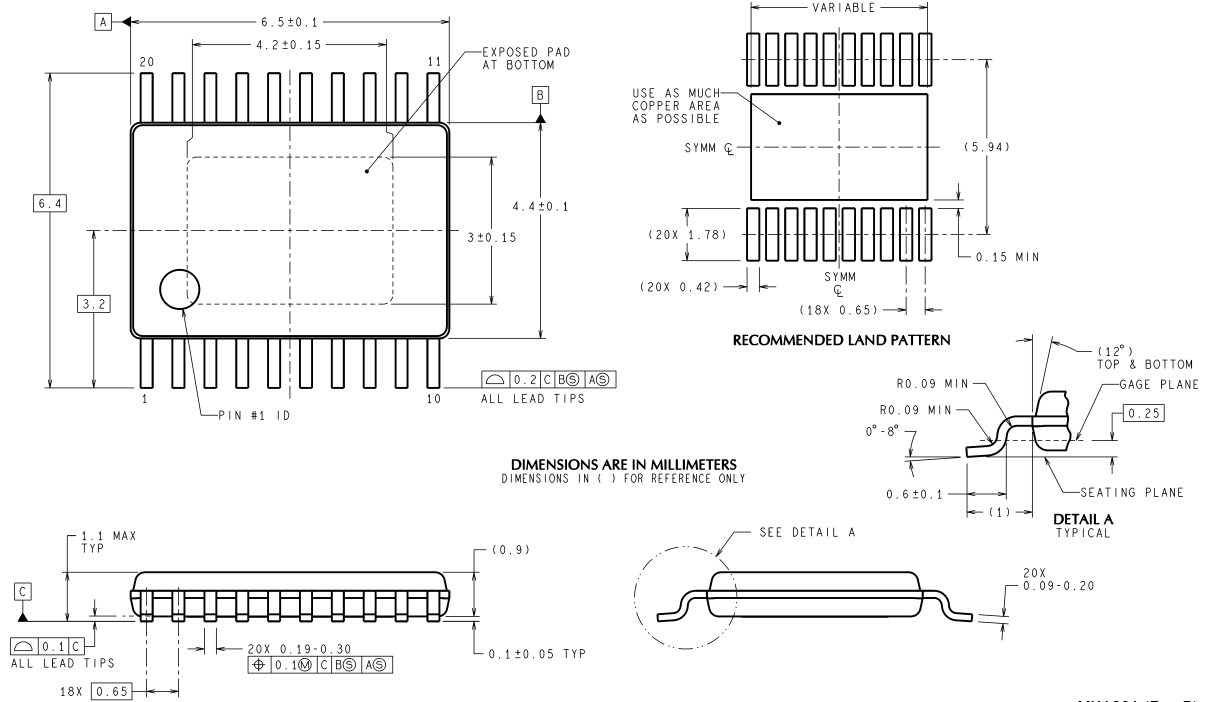

MH Package
Order Number LM4668MH
NS Package Number MXA20A

MXA20A (Rev B)

National does not assume any responsibility for use of any circuitry described, no circuit patent licenses are implied and National reserves the right at any time without notice to change said circuitry and specifications.

For the most current product information visit us at www.national.com.

LIFE SUPPORT POLICY

NATIONAL'S PRODUCTS ARE NOT AUTHORIZED FOR USE AS CRITICAL COMPONENTS IN LIFE SUPPORT DEVICES OR SYSTEMS WITHOUT THE EXPRESS WRITTEN APPROVAL OF THE PRESIDENT AND GENERAL COUNSEL OF NATIONAL SEMICONDUCTOR CORPORATION. As used herein:

1. Life support devices or systems are devices or systems which, (a) are intended for surgical implant into the body, or (b) support or sustain life, and whose failure to perform when properly used in accordance with instructions for use provided in the labeling, can be reasonably expected to result in a significant injury to the user.
2. A critical component is any component of a life support device or system whose failure to perform can be reasonably expected to cause the failure of the life support device or system, or to affect its safety or effectiveness.

BANNED SUBSTANCE COMPLIANCE

National Semiconductor certifies that the products and packing materials meet the provisions of the Customer Products Stewardship Specification (CSP-9-111C2) and the Banned Substances and Materials of Interest Specification (CSP-9-111S2) and contain no "Banned Substances" as defined in CSP-9-111S2.



National Semiconductor
Americas Customer
Support Center
 Email: new.feedback@nsc.com
 Tel: 1-800-272-9959

National Semiconductor
Europe Customer Support Center
 Fax: +49 (0) 180-530 85 86
 Email: europe.support@nsc.com
 Deutsch Tel: +49 (0) 69 9508 6208
 English Tel: +44 (0) 870 24 0 2171
 Français Tel: +33 (0) 1 41 91 8790

National Semiconductor
Asia Pacific Customer
Support Center
 Email: ap.support@nsc.com

National Semiconductor
Japan Customer Support Center
 Fax: 81-3-5639-7507
 Email: jpn.feedback@nsc.com
 Tel: 81-3-5639-7560

www.national.com